

Capture and record information on whiteboard

Board Area Capture Mode

Capture and record handwriting information on whiteboard combines with projection image on the same whiteboard

- 1 Click Presentation and select Board Area Capture Mode
- 2 Point camera part at the whiteboard
- 3 Adjust capturing frame by wide and tele button on Window of Board Area Capture
- 4 Click shutter button on dialog box to capture image

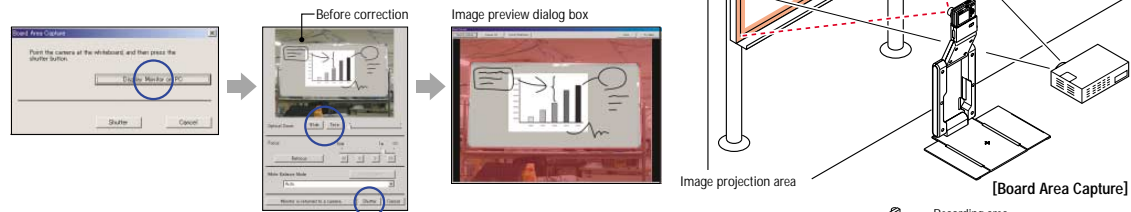

*For more information, see Software User's Guide

In case of recording area same as projection area, click Projection Area Capture button

*For more information, see Software User's Guide

Project stored image on computer

Select PC image mode

- 1 Click PC Image Mode button
Thumbnail of image files on preview list area appears
- 2 Double-click a thumbnail for projection
Click Full Screen/Full Screen Off to go back to preview list area

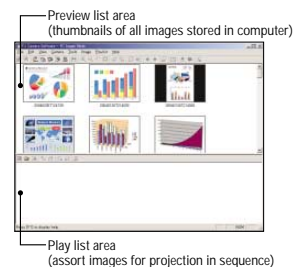

Useful function of PC image mode

Assort stored images for projection in sequence
Select images on preview list, and drag and drop them to play list area

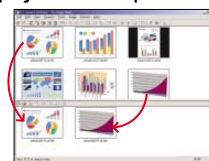

*For more information, see Software User's Guide

Project images recorded by detached camera unit

Camera Image Mode

Project images stored in camera unit by attached back to YC-400' stand without transferring data from camera

- 1 Attach back camera unit into YC-400's stand after recording images
- 2 Click Camera Image Mode button
Preview list of images recorded by camera unit appears
- 3 Double-click a thumbnail for projection

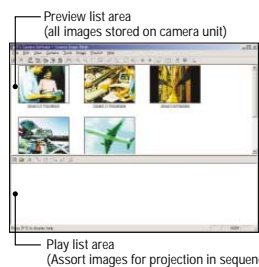

Useful function of Camera image mode

Correct image taken from diagonal angle
Automatically correct distortion in a image in Business Shot Mode

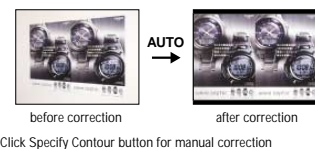

Assort images for projection in sequence
Select images on preview list area, and drag and drop them to play list area

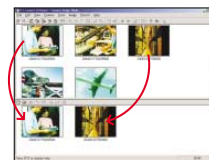

*For more information, see Software User's Guide

Multifunctional Camera System

YC-400

Quick Guide Multi PJ Startup Mode

*The Multi PJ startup mode provides access to all of the features and functions (document camera, scanner, etc.) of the PJ Camera Software. This Quick Guide provides you with a comprehensive overview of what you can do with the PJ Camera Software.



1 INSTALL SOFTWARE

Install YC400's software from CD-ROM bundled with this product on a Computer



*For more information, see YC-400 User's Guide



*After the computer starts up, make sure PJ Camera Software icon is in the Windows taskbar.

2 SET UP YC-400

1 Unfold stage and stand of YC-400

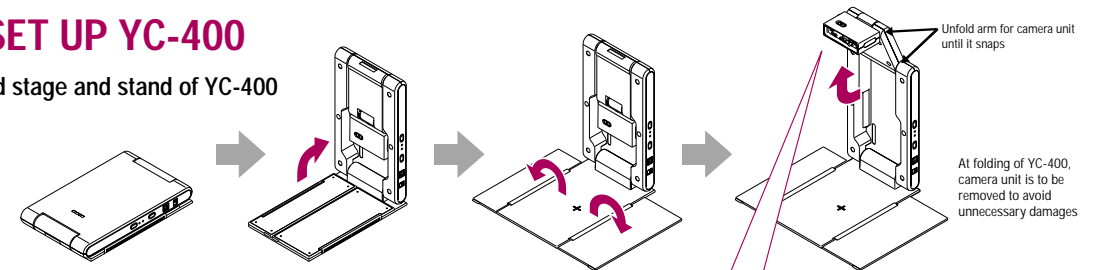

Camera unit removed from YC400 can be used as stand-alone digital camera

Insert camera battery (NP-20) bundled with this product into camera unit

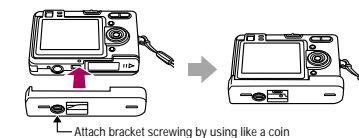

*For more information, see YC-400 User's Guide

2 Attach camera unit to YC400 stand until it clicks securely

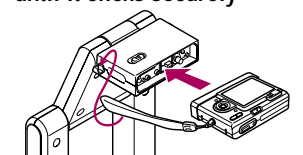

3 CONNECTION

Connect YC-400, projector and computer

YC-400 and computer connected by USB cable bundled with this product

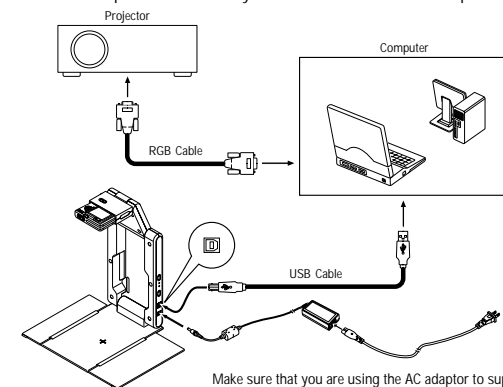

*For more information, see YC-400 User's Guide

*RGB Cable is not bundled with this product

4 START UP PJ Camera Software

Turn on power button on YC400 stand, PJ camera Software will start up automatically and a dialog will appear.

All operations of YC-400 are controlled by PJ Camera Software

Never touch YC-400 while the automatic camera position adjustment operation is being performed because Auto Sensor is in process.

Dialog Box

Business Document Mode

Multi PJ Mode

Select Multi PJ Mode

*For more information, see YC-400 User's Guide

By moving mouse pointer to the top center of the computer screen, the operation bar combines a menu bar and tool bar appears

Reference of Toolbar button

File Edit View Camera Tools Image Playlist Help

Projection Area Capture Board Area Capture Document Camera PC Image Camera Image Scanner Presentation Save Zoom In Zoom Out Scroll Fit Image Rotate Right Rotate Left Specify Contour Correct Brightness Back Forward Full Screen/Full Screen Off Trapezoid Correction Small Document 3D Object Shutter Quit

*When "Document Camera Mode" is selected, "Show Document Monitor" button appears instead of "Full Screen/Full Screen Off" button.

How to put document or object on the stage, and how to select suitable mode

Place document or object in the center of the document stage covering [+] mark

Document Camera Mode

	Trapezoid Correction	Small Document	3D Object
Document like letter size	ON	OFF	OFF
Large document like newspaper	ON	OFF	OFF
Small document like business card	ON	ON	OFF
3D object	—	OFF	ON

Click suitable buttons as per size of document or object

Scanner Mode

	Small Document	3D Object	
Document like letter size	OFF	OFF	Document like letter size Large document like newspaper
Small document like business card	ON	OFF	Small document like business card
3D object	OFF	ON	3D object

Click suitable buttons as per size of document or object

Record document or object and project its image

Document Camera Mode

1 Place document like letter size on the document stage

Inclination, distortion, color and tones of document and object are automatically corrected and projected

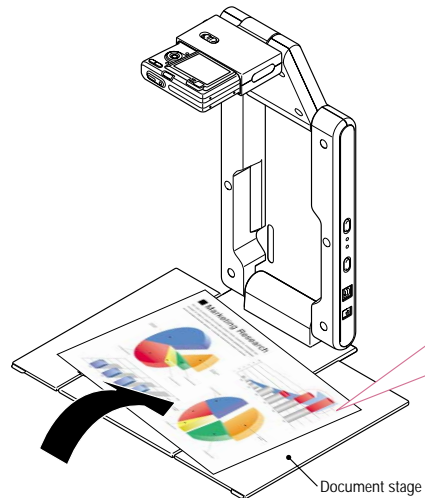

Even when document is placed roughly, it is recorded as proper full-resolution image

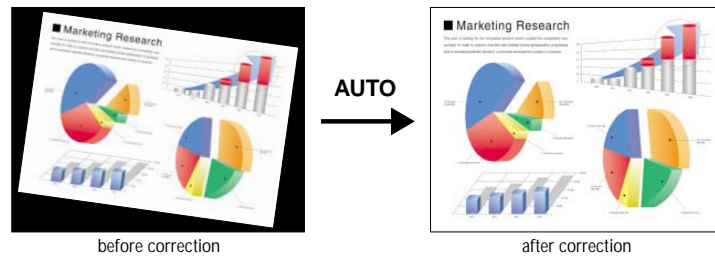

Provide enough illumination for document or object
Dark shadow will affect the sensor to capture properly

*For more information, see Software User's Guide

Useful function

By replacing document or object, record it and project its image automatically

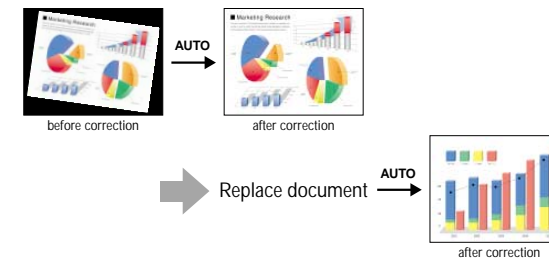

Change images

Click Forward [Next] button to forward image, click Back [Previous] button to previous image

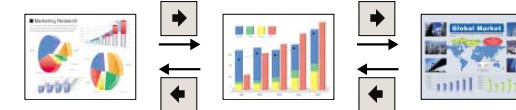

Zoom-in, zoom-out image

Click Zoom-In [Magnifying Glass] for close-up, click Zoom-Out [Magnifying Glass] for normal size, click Scroll [Hand] to move the image around



Rotate image

Click Rotate Left [Rotate Left] to rotate left for 90 degrees, click Rotate Right [Rotate Right] to rotate right for 90 degrees

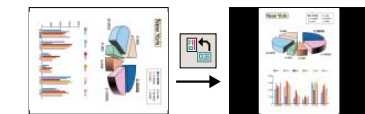

Store image

Click Save [Save] button, and indicate folder and file name to store image

Record images of document or object on computer

Scanner Mode

1 Click Scanner Mode [Scanner] button to enter Scanner Mode

Never touch YC-400 while the automatic camera position adjustment operation is being performed because Auto Sensor is in process.

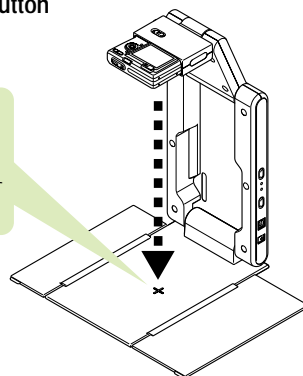

2 Place document or object on the stage

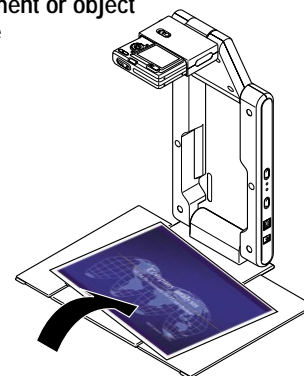

*For more information, see Software User's Guide

3 Press start [Start] button to start scanning

Scan item automatically by replacing a new documents or object



Adjust frame size according to scanning object

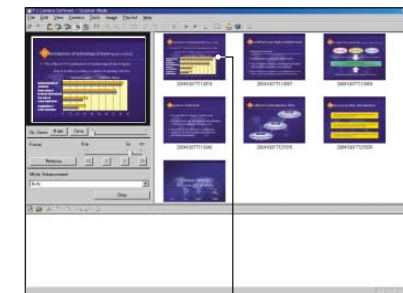

Thumbnail of recorded images
(Once scanning is completed, its image is listed as first on preview list area)

4 Click stop [Stop] button to finish auto scanning

